



# SeBaPRO4 Series Digital Microscope Systems



Version 2.0

# Brochure

# INTRODUCTION

LAXCO has been a leading provider of high precision, cutting edge optical instruments and microscopes for over 30 years. Our products span a complete range of applications including education, clinical, life science research, and industrial. Our commitment to engineering excellence, breakthrough innovations, and cost effective solutions, makes us one of the most reliable suppliers in the industry. Our products come with a heritage of technical strength, manufacturing discipline, and a prominent reputation of advanced engineering. We currently hold over 15 patents for lighting, design, and technology and our designs incorporate numerous innovative features, address issues others may overlook, and come with a strong industry-proven reputation. Product development is based in Washington State with electrical, mechanical, and optical engineers on site.

Introducing the redesigned biological microscope, ideal for basic research, clinical and classroom applications and the infinity color correction optical system creates bright, high resolution images at any magnification. The user-friendly design, expanded base for stability, simple and convenient operation, allows users to easily master operation. Similarly, same as with all Laxco microscopes, the SeBaPRO4 Series maintains excellent reliability and durability, and is suitable for high-intensity use in all markets.

## MICROSCOPY REDEFINED

### View

Comfortably view live and captured images on a large touchscreen display or project them to a separate screen via HDMI.

### Capture

Quickly capture images and upload them to the SeBaShare Cloud or save to a USB drive.

### Collaborate

Our secure SeBaShare Cloud allows users to easily share images with colleagues, labs, and collaborators anywhere online.

## KEY FEATURES

- Fixed Binocular (SeBaP4B) and Tilting Binocular (SeBaP4C2) head  
22mm FOV/10x eyepieces
- 6-position objective nose-piece
- Touchscreen display
- 16MP color camera
- Easily capture, review, measure, print, and annotate images
- Upload images to SeBaShare or save to USB drive
- Plan APO, plan fluor or plan achromatic infinity objectives
- Wide range of magnifications: 2x, 4x, 10x, 20x, 40x, 60x, and 100x
- Parcentered and parfocal objectives
- Rack and pinion focusing mechanism for smooth focus control
- X/Y rackless wire-driven stage
- Full Koehler illumination with field and iris diaphragm

## THE MODERN LABORATORY

Digital Microscopy is becoming increasingly more important in Clinical and Life Science applications. Digital images are necessary for documentation, communication, secondary diagnosis, teaching, and analysis. Traditional digital microscopy often times requires multiple components from different manufactures, which require complex installations and lots of loose wires.

SeBaPRO4 Series changes the way you view your microscope by simplifying the complexities of a traditional microscope. It incorporates seamless integration of camera, computer and monitor creating an easy-to-use, all-in-one digital microscope that is perfect for any environment. Its small footprint saves a lab's valued bench space by eliminating the need to have a computer sitting next to it, or any other additional equipment. SeBaPRO4 Series brings collaboration, teaching, routine scanning, and image documentation into the next generation! Innovative technology includes the SeBaShare™ cloud.

### TRADITIONAL



VS

### MODERN



# CONTRAST METHODS

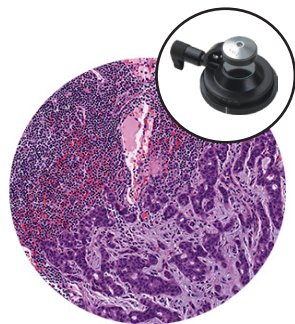

## BRIGHTFIELD

- Full Koehler Illumination
- Adjustable iris for increased depth of focus and contrast
- Brilliant color correctness

## ADVANCED GOUT KIT

- Polarizer, analyzer and compensator
- Tests for gout

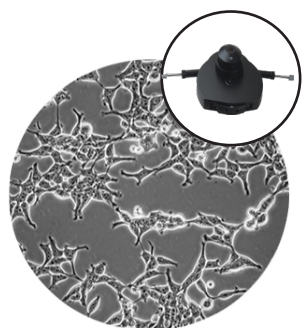
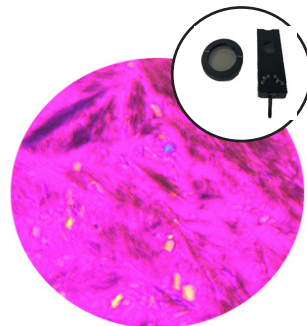

## PHASE CONTRAST

- Full Koehler Illumination
- Adjustable iris for increased depth of focus and contrast
- Brilliant color correctness

## CROSS POLARIZATION

- Polarizer and analyzer
- Simple polarization
- Used to identify presence of crystal structures

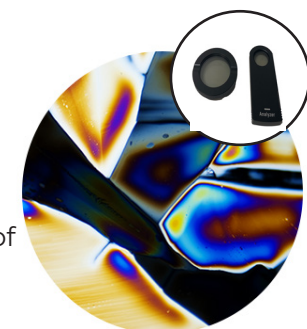

When equipped with the appropriate accessories, the SeBaPRO4 Series is capable of the above contrast methods.

# ERGONOMICS

## SeBaPRO4 Series Digital Imaging System Elevates Ergonomics to a New Level

The SeBaPRO4 Series offers advanced ergonomic features designed to eliminate a sore, stiff neck, or trouble focusing your eyes from eyestrain. The SeBaPRO4 offers the perfect solution allowing specimen observation through traditional binoculars or ergo tilting binoculars on the SeBaPRO4C2 or on a touchscreen display. Scan your slides and when you want a traditional look, the binoculars are there. And if you get tired of sitting, the SeBaPRO4 tilts back for observation while standing eliminating many of the physical ailments of routine day to day microscope viewing.

0° to 80° TILTING ERGONOMIC TOUCHSCREEN

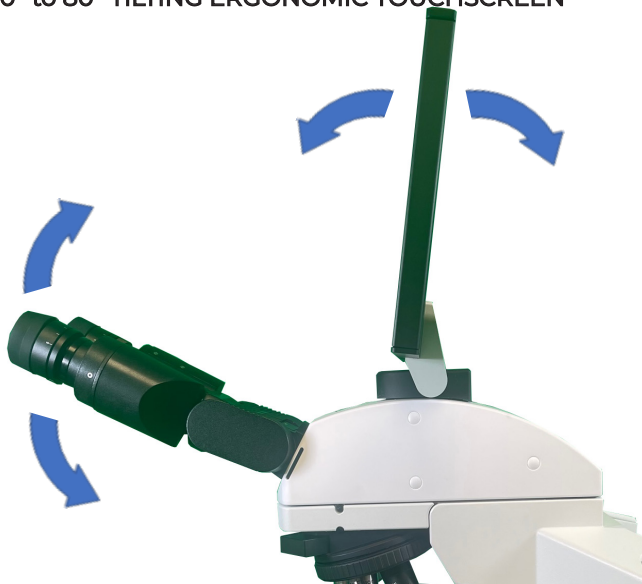

0° to 30° TILTING ERGONOMIC BINOCULAR

	<b>SEBAP4B-BFI</b>	<b>SEBAP4B-PHI</b>
<b>OPTICAL SYSTEM</b>	Infinity corrected	Infinity corrected
<b>OBSERVATION TUBE</b>	ERGO Binocular Observation Tube with 0° to 30° tilt	ERGO Binocular Observation Tube with 0° to 30° tilt
<b>TOUCHSCREEN</b>	Touchscreen Display	Touchscreen Display
<b>OBJECTIVES</b>	Infinity plan achromatic objective (2X, 4X, 10X, 20X, 40X, 100X)	Infinity plan achromatic (4X) and positive phase contrast objectives ( 10x, 20x, 40x, 100x)
<b>EYEPIECES</b>	High eye point wide field plan eyepiece PL 10X/22mm, with adjustable diopter	High eye point wide field plan eyepiece PL 10X/22mm, with adjustable diopter
<b>FIELD OF VIEW</b>	22mm	22mm
<b>KOEHLER</b>	Full Koehler Illumination	Full Koehler Illumination
<b>FOCUS</b>	Coarse and Fine - low position coaxial focusing mechanism, coarse range: 25mm, fine precision: 0.002mm, with tension adjustment and upper limit	Coarse and Fine - low position coaxial focusing mechanism, coarse range: 25mm, fine precision: 0.002mm, with tension adjustment and upper limit
<b>CONDENSER</b>	0.9 N.A. Condenser with swing-out top element	0.9 N.A. Condenser with swing-out top element
<b>ILLUMINATION</b>	3W LED	3W LED
<b>STAGE</b>	X/Y rackless wire-driven stage	X/Y rackless wire-driven stage
<b>NOSEPIECE</b>	6 Position inward facing	6 Position inward facing

## STANDARD CONFIGURATIONS

	SEBAP4C2-BF1	SEBAP4C2-PH1
OPTICAL SYSTEM	Infinity corrected	Infinity corrected
OBSERVATION TUBE	ERGO Tilting Binocular Observation Tube with 0° to 30° tilt	ERGO Tilting Binocular Observation Tube with 0° to 30° tilt
TOUCHSCREEN	Touchscreen Display	Touchscreen Display
OBJECTIVES	Infinity plan achromatic objective (2X, 4X, 10X, 20X, 40X, 100X)	Infinity plan achromatic (4X) and positive phase contrast objectives ( 10x, 20x, 40x, 100x)
EYEPIECES	High eye point wide field plan eyepiece PL 10X/22mm, with adjustable diopter	High eye point wide field plan eyepiece PL 10X/22mm, with adjustable diopter
FIELD OF VIEW	22mm	22mm
KOEHLER	Full Koehler Illumination	Full Koehler Illumination
FOCUS	Coarse and Fine - low position coaxial focusing mechanism, coarse range: 25mm, fine precision: 0.002mm, with tension adjustment and upper limit	Coarse and Fine - low position coaxial focusing mechanism, coarse range: 25mm, fine precision: 0.002mm, with tension adjustment and upper limit
CONDENSER	0.9 N.A. Condenser with swing-out top element	0.9 N.A. Condenser with swing-out top element
ILLUMINATION	3W LED	3W LED
STAGE	X/Y rackless wire-driven stage	X/Y rackless wire-driven stage
NOSEPIECE	6 Position inward facing	6 Position inward facing

## UPGRADE KITS

PATHOLOGY	SEBAP4C2-PAT-KIT	APO - 1.25 1.2N.A. SWING OUT CONDENSER PLAN ACHRO - 60x
HISTOLOGY	SEBAP4C2-HIST-KIT	PLAN ACHRO - 50x OIL IMMERSION
GOUT	SEBAP4C2-GOUT-KIT	ADVANCED GOUT KIT
URINALYSIS	SEBAP4C2-URI-KIT	SIMPLE POLARIZER KIT
MICROBIOLOGY	SEBAP4C2-MICR-KIT	PLAN ACHRO - 100x OIL IMMERSION 1.2N.A. SWING OUT CONDENSER

# SEBA SOFTWARE TOUCHSCREEN INTERFACE

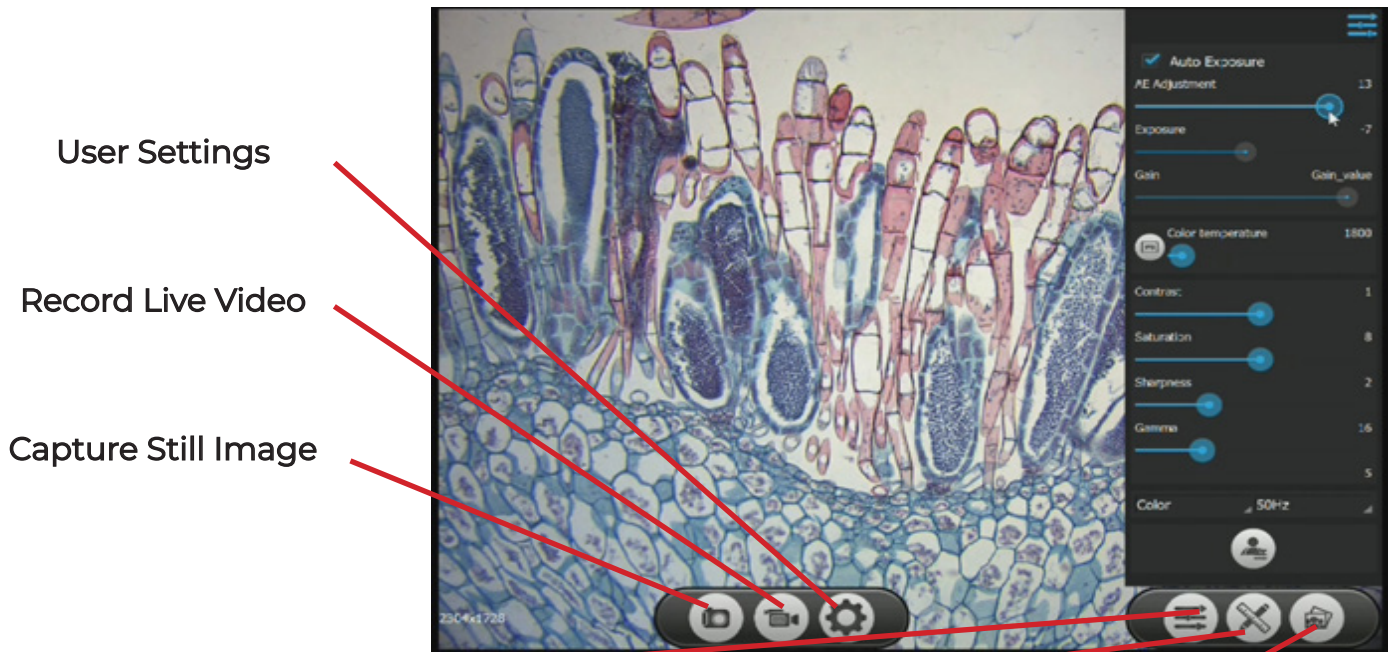

User Settings

Record Live Video

Capture Still Image

## Effects Menu

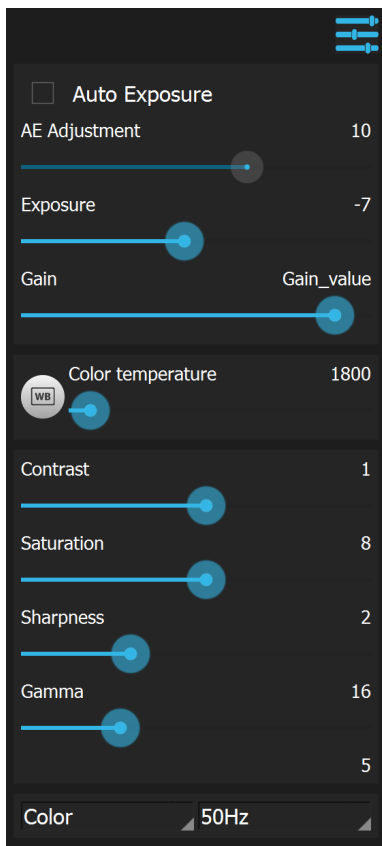

Adjust exposure, white balance, color, brightness, contrast of live image.

## Measure Menu

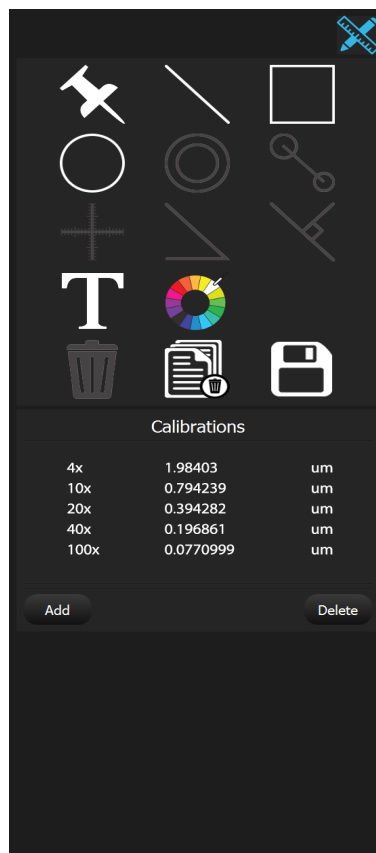

Perform measurements on image.

## Gallery Menu

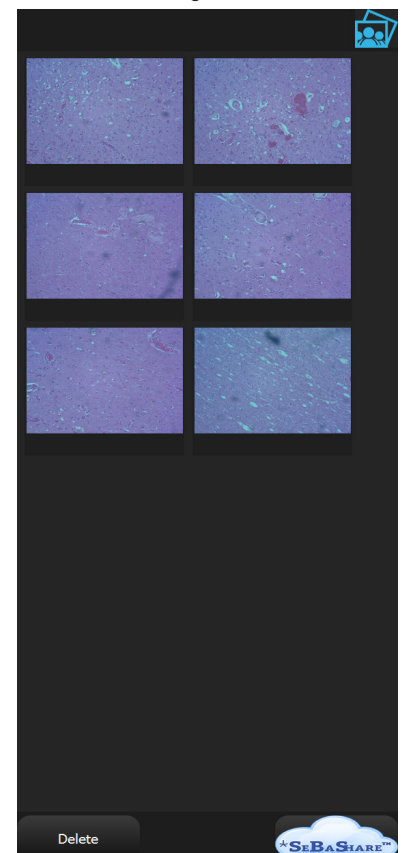

Review captured images and upload to SeBaShare.

# GREAT FOR PRESENTATION & DOCUMENTATION

## BEAUTIFULLY DIGITAL

- Live image graphical overlay
- Freeze, save, recall, print, and annotate images
- Saved images as .JPG, .PNG, or .TIFF w/ annotation and measurements
- On-screen calibration
- Crop, vertical & horizontal scale rulers, and multi-window viewing



### DIMENSIONS

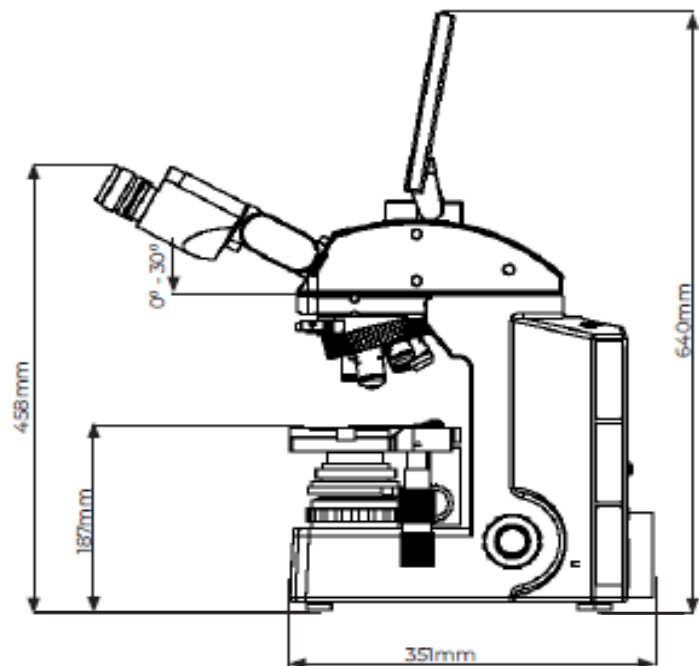
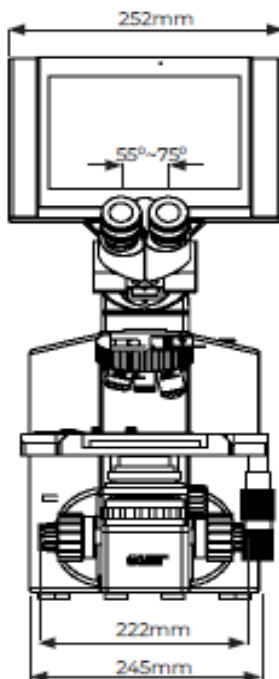





---

LAXCO, Inc.  
18303 Bothell-Everett Hwy  
Suite 140  
Mill Creek, WA 98012  
[www.laxcoinc.com](http://www.laxcoinc.com)

Contact us:  
425-686-3081  
[sales@laxco.com](mailto:sales@laxco.com)

SEBA-MKT-DOC-1700097(2)